

Description

The open LED protector provides a switching electronic shunt path when an LED in an LED string fails as an open circuit. This ensures that the entire array of LEDs will continue to function even if a single LED in the array does not. This provides higher reliable lighting functions in applications such as headlights, aircraft lights, airport runway lighting, roadside warning lights, etc. This device is designed to be used with one watt LEDs, nominally 350mA @ 3V, and is available in POWERMITE® package (CSP) which is ideal for dense board applications.

Pinout Diagram

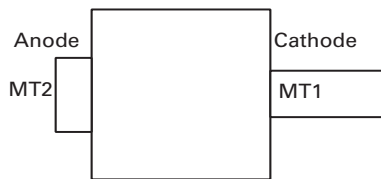

Features & Benefits

- Fast switching
- Automatically resets after power cycle
- Available in low profile, small footprint POWERMITE® packages
- Compatible with industrial lighting environments
- Compatible with PWM frequencies up to 10 kHz
- RoHS compliant and halogen-free

Schematic Symbol

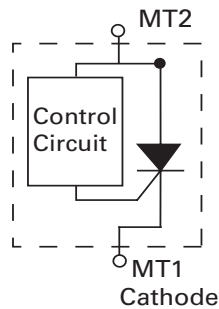

Electrical Characteristics(All parameters are measured at T_A=25°C unless otherwise noted)

Part Number	Marking	V _{BR} @ I _{BR} = 1 mAmps		I _{LEAK} @ I _{MT2} = 5V	I _H	I _S	I _T @V _T	V _T @ I _T = 350mA	V _T @ I _T = 1A	V _T @ I _T = 1.3A	Critical rate of rise dV/dt	Capacitance @ 1MHz, 2V bias
		Volts		uA	mA	mA	A	V	V	V		
		Min	Max	Max	Max	Max	Max	Typ	Typ	Max		
PLED6M	P6M	5.5	7.5	250	12	70	1.0 ^{1,2}	1.2	1.15	1.2	250	24

Notes:

- 1) Standard FR-4 PCB with Copper Pads (2mm x 2mm/pad)
- 2) Aluminum PCB Pads (2mm x 3mm/pad)

Thermal Considerations

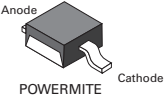
Package	Symbol	Parameter	Value	Unit
 <p>POWERMITE</p>	I_T	Average On-State Current, ($T_A = 25^\circ\text{C}$)	1.0 ^{1 2}	A
	V_T	On-state Voltage ($T_A = 125^\circ\text{C}$)	1.0	V
	P_D	Power Dissipation ($T_A = 25^\circ\text{C}$)	1.45 ¹	W
			1.50 ²	
	T_J	Operating Junction Temperature Range	80 ¹	$^\circ\text{C}$
			50 ²	
	T_S	Storage Temperature Range	-65 to +150	$^\circ\text{C}$
	$R_{\theta JL}$	Thermal Resistance: Junction to Lead	25 ¹	$^\circ\text{C}/\text{W}$
20 ²				
$R_{\theta JA}$	Thermal Resistance: Junction to Ambient	80 ¹	$^\circ\text{C}/\text{W}$	
		50 ²		

Notes:

- 1) Standard FR-4 PCB with Copper Pads (2mm x 2mm/pad)
- 2) Aluminum PCB Pads (2mm x 3mm/pad)
- * POWERMITE® is a registered trademark of Microsemi Corporation.

V-I Characteristics

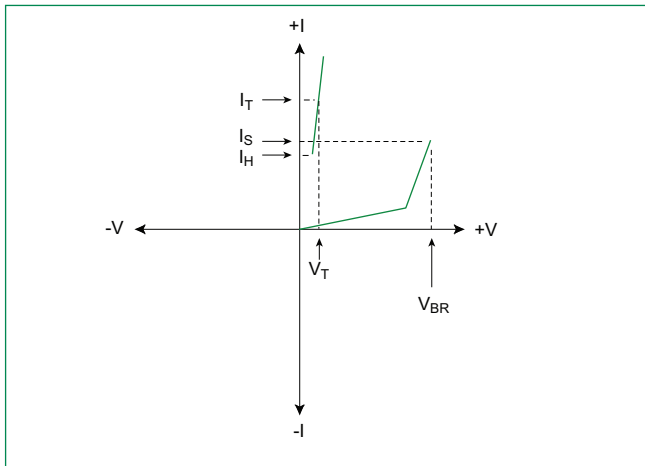

V_{BR} vs. Junction Temperature

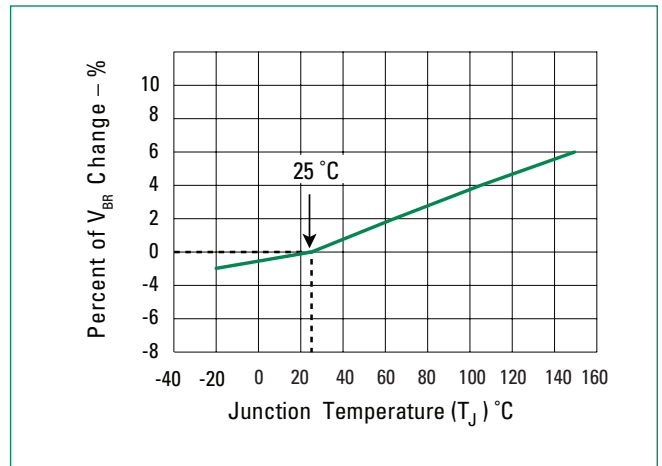

Normalized DC Holding Current vs. Ambient Temperature

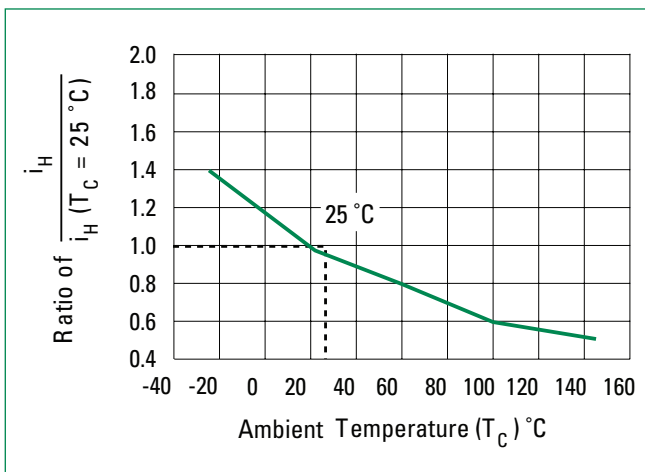

Capacitance vs Voltage

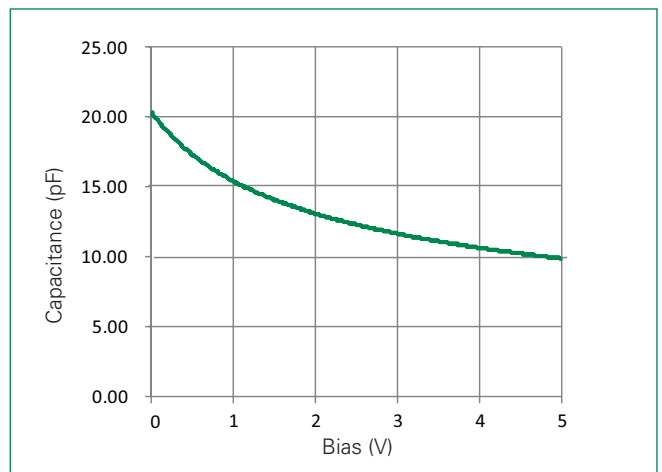

Leakage Current vs Temperature

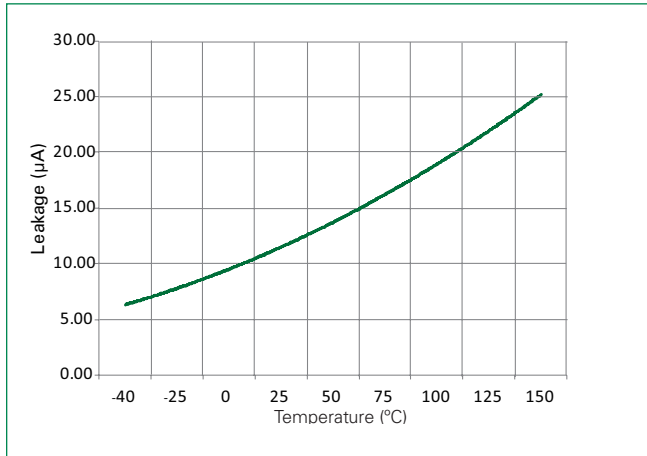

LED Interference Test Circuit

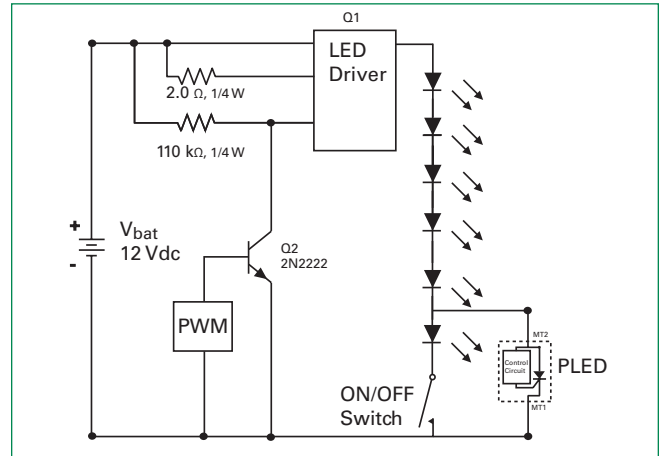

Operating Current vs. Ambient Temperature

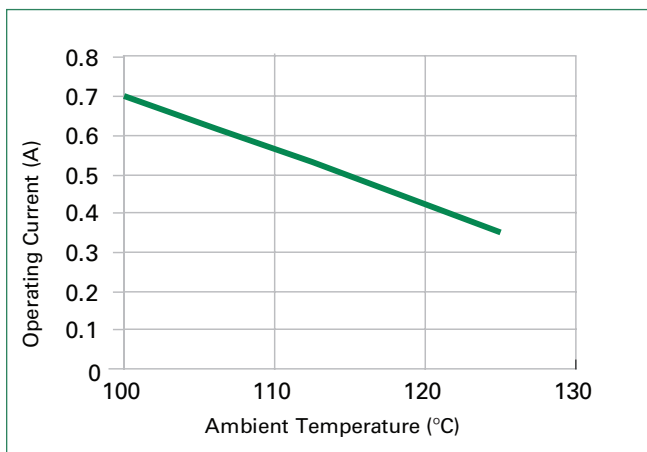

Typical Operation Waveforms

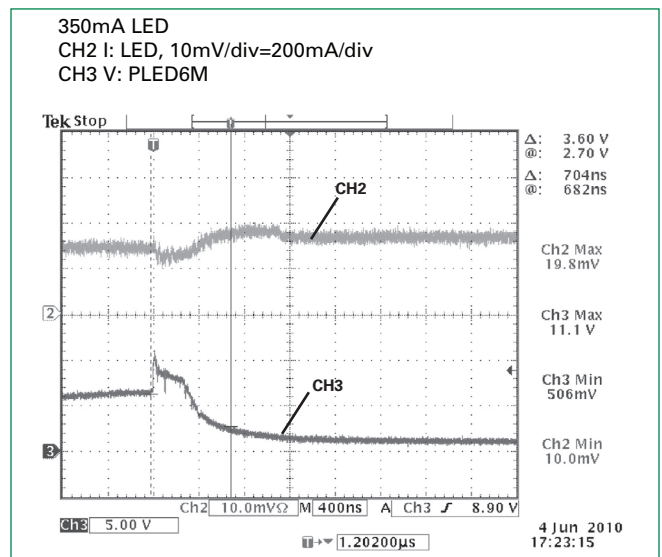
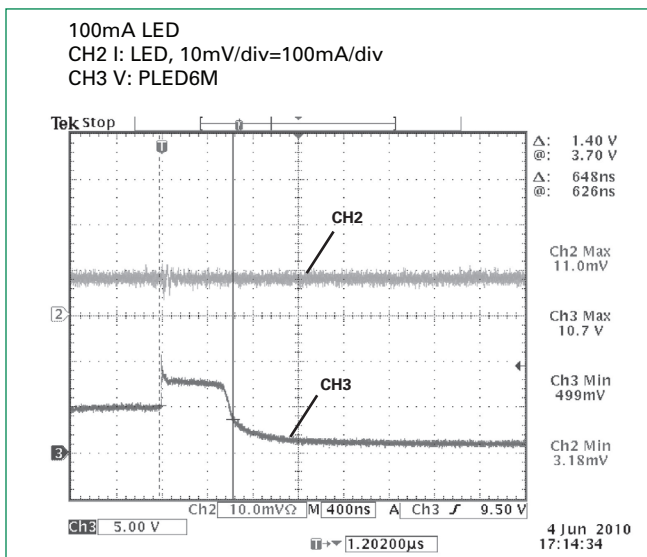

Soldering Parameters

Reflow Condition		Pb – Free assembly
Pre Heat	- Temperature Min ($T_{s(min)}$)	150°C
	- Temperature Max ($T_{s(max)}$)	200°C
	- Time (min to max) (t_s)	60 – 180 secs
Average ramp up rate (Liquidus Temp (T_L) to peak)		3°C/second max
$T_{s(max)}$ to T_L - Ramp-up Rate		3°C/second max
Reflow	- Temperature (T_L) (Liquidus)	217°C
	- Temperature (t_L)	60 – 150 seconds
Peak Temperature (T_p)		260 ^{+0/-5} °C
Time within 5°C of actual peak Temperature (t_p)		30 seconds
Ramp-down Rate		6°C/second max
Time 25°C to peak Temperature (T_p)		8 minutes max
Do not exceed		260°C

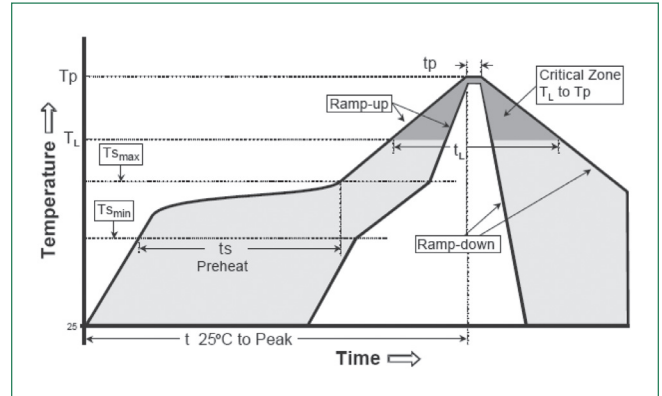

Physical Specifications

Terminal Material	Copper Alloy
Terminal Finish	100% Matte Tin Plated
Body Material	UL recognized epoxy meeting flammability classification 94V-0

Packaging

Package Code	Description	Packaging Quantity	Industry Standard
M	POWERMITE	3000	EIA-481-1 Tape and Reel

Part Numbering System

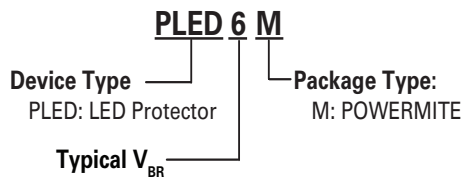

Environmental Specifications

High Temperature Voltage Blocking	MIL-STD-750: Method 1040, Condition A 80% min V_{BR} DC, 150°C, 504 hours
Temperature Cycling	MIL-STD-750: Method 1051 -65°C to 150°C, 15-minute dwell, 100 cycles
Biased Temperature & Humidity	EIA/JEDEC: JESD22-A101 80% min V_{BR} , 85°C, 85% RH, 1008 hours
Resistance to Solder Heat	MIL-STD-750: Method 2031 260°C, 10 seconds
Moisture Sensitivity Level	JEDEC-J-STD-020, Level 1
Burn-In Test	$T_j = 150^\circ\text{C}$, $I_T = 0.350 \text{ Adc}$, 1008 hours

Part Marking System

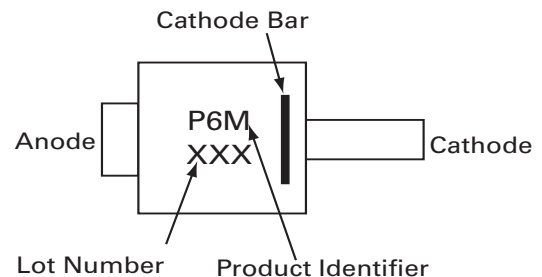

Dimensions - POWERMITE® Package

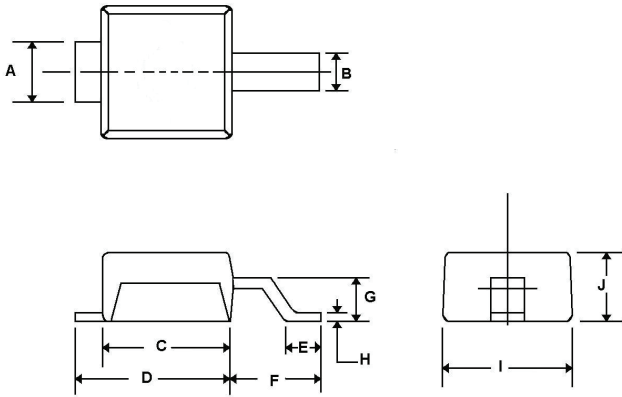

Dimensions	Millimeters		Inches	
	Min	Max	Min	Max
A	0.73	0.99	0.029	0.039
B	0.40	0.66	0.016	0.026
C	1.77	2.03	0.070	0.080
D	2.21	2.46	0.087	0.097
E	0.50	0.76	0.020	0.030
F	1.29	1.54	0.051	0.061
G	0.53	0.78	0.021	0.031
H	0.10	0.20	0.004	0.008
I	1.77	2.03	0.070	0.080
J	0.89	1.14	0.035	0.045

Tape and Reel Specification - POWERMITE® Package

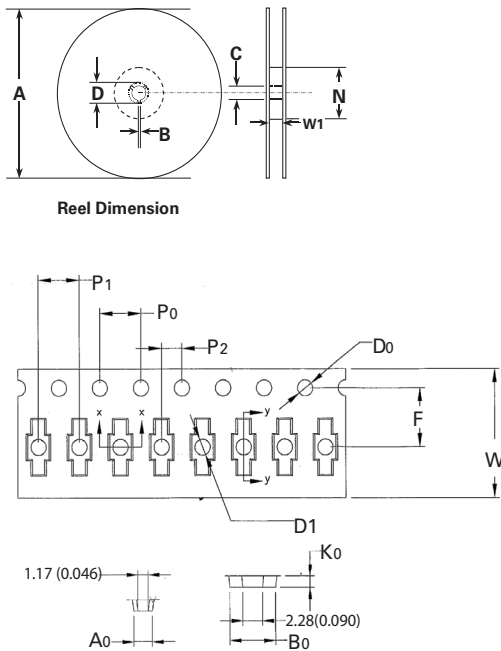

Symbols	Description	Inches			Millimeters		
		MIN	TYP	MAX	MIN	TYP	MAX
A	Reel Diameter	-	-	7.087	-	-	180.00
B	Drive Spoke Width	0.098	0.157	0.217	2.50	4.00	5.50
C	Arbor Hole Diameter	0.504	0.512	0.520	12.80	13.00	13.20
D	Drive Spoke Diameter	0.795	-	-	20.20	-	-
N	Hub Diameter	2.343	2.362	2.382	59.50	60.00	60.50
W1	Reel Inner Width at Hub	0.472	0.488	0.508	12.00	12.40	12.90
A0	Pocket Width at Bottom	0.078	0.082	0.086	1.98	2.08	2.18
B0	Pocket Length at Bottom	0.198	0.202	0.206	5.04	5.14	5.24
D0	Feed Hole Diameter	0.055	0.059	0.063	1.40	1.50	1.60
D1	Pocket Hole Diameter	0.053	0.059	0.069	1.35	1.50	1.75
F	Feed Hole Center-Pocket Hole Center 2	0.197	0.217	0.236	5.00	5.50	1.60
K0	Pocket Depth	0.044	0.048	0.052	1.11	1.21	1.31
P0	Feed Hole Pitch	0.154	0.157	0.161	3.90	4.00	4.10
P1	Component Spacing	0.154	0.157	0.161	3.90	4.00	4.10
P2	Feed Hole Center-Pocket Hole Center 1	0.077	0.079	0.081	1.95	2.00	2.05
W	Embossed Carrier Tape Width	0.469	0.472	0.484	11.90	12.00	12.30
	Cover Tape Width	-	0.366	-	-	9.30	-